

RoHS Compliant

端子图

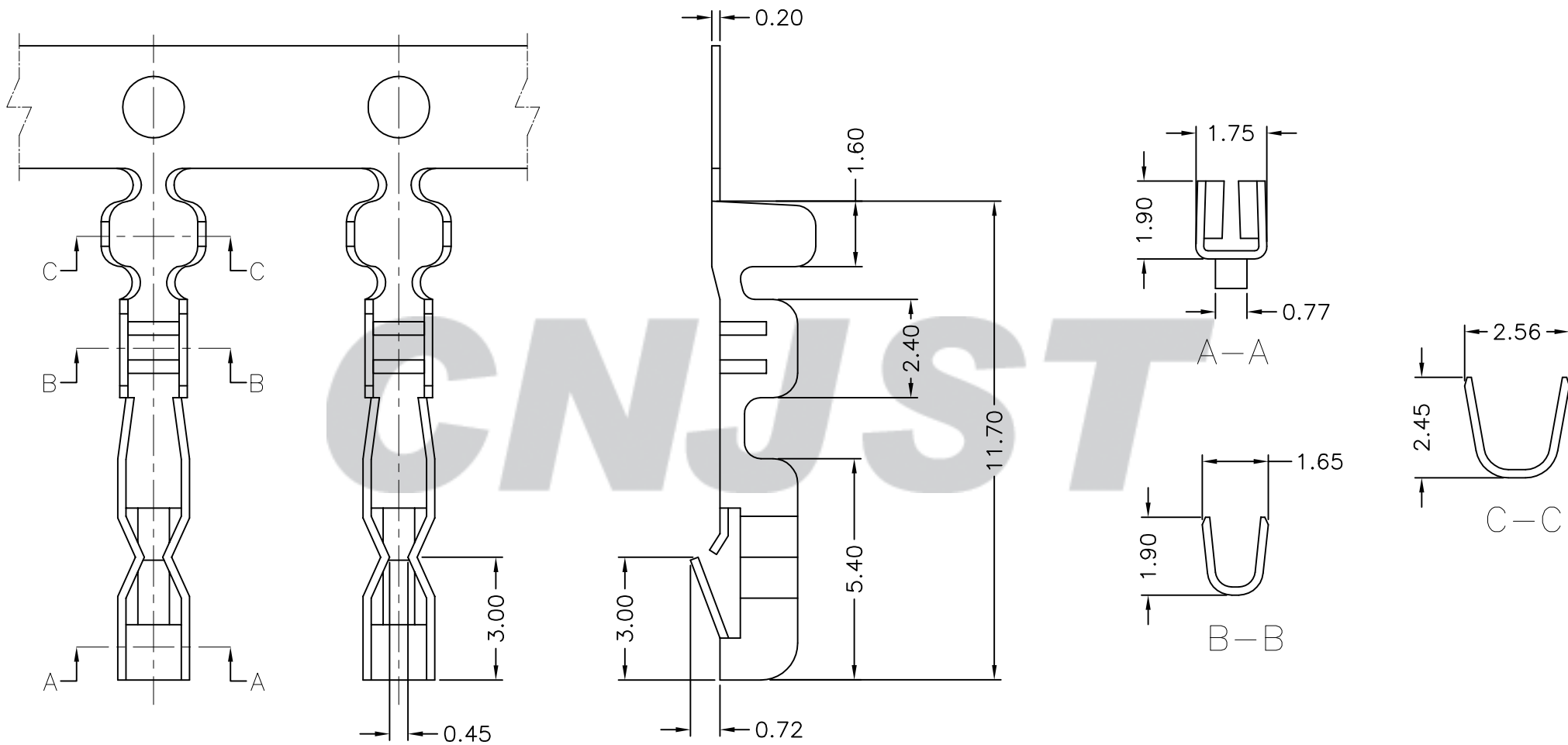
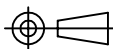

Tolerance X.X ±0.30 X.XX ±0.20 X.XXX ±0.10 Angle ±3.0°	Model Name: 2.50mm PITCH CRIMP TERMINAL		Drawn: 张育斌2016.06.13
	Model No: A2506T-PA-Z		
UNIT: mm		SCALE: FULL	REVISION: B/1
		<b>CNJST</b> 浙江捷仕泰电子有限公司 ZHEJIANG JIESHITAI ELECTRONIC CO., LTD	
			Checked: 林旭芝
			Approved: 刘祚杰
			DWG NO. CNJST/GCDZ-0044

REV.	DATE	DESCRIPTION	APPD.	Wire Range	Insulation O.D.	QTY/Reel	Material	Plating
1	2013.01.01	NEW RELEASE		AWG #20~#26	1.90mm(max)	10,000Pcs	Phosphor Bronze	Tin-plated