

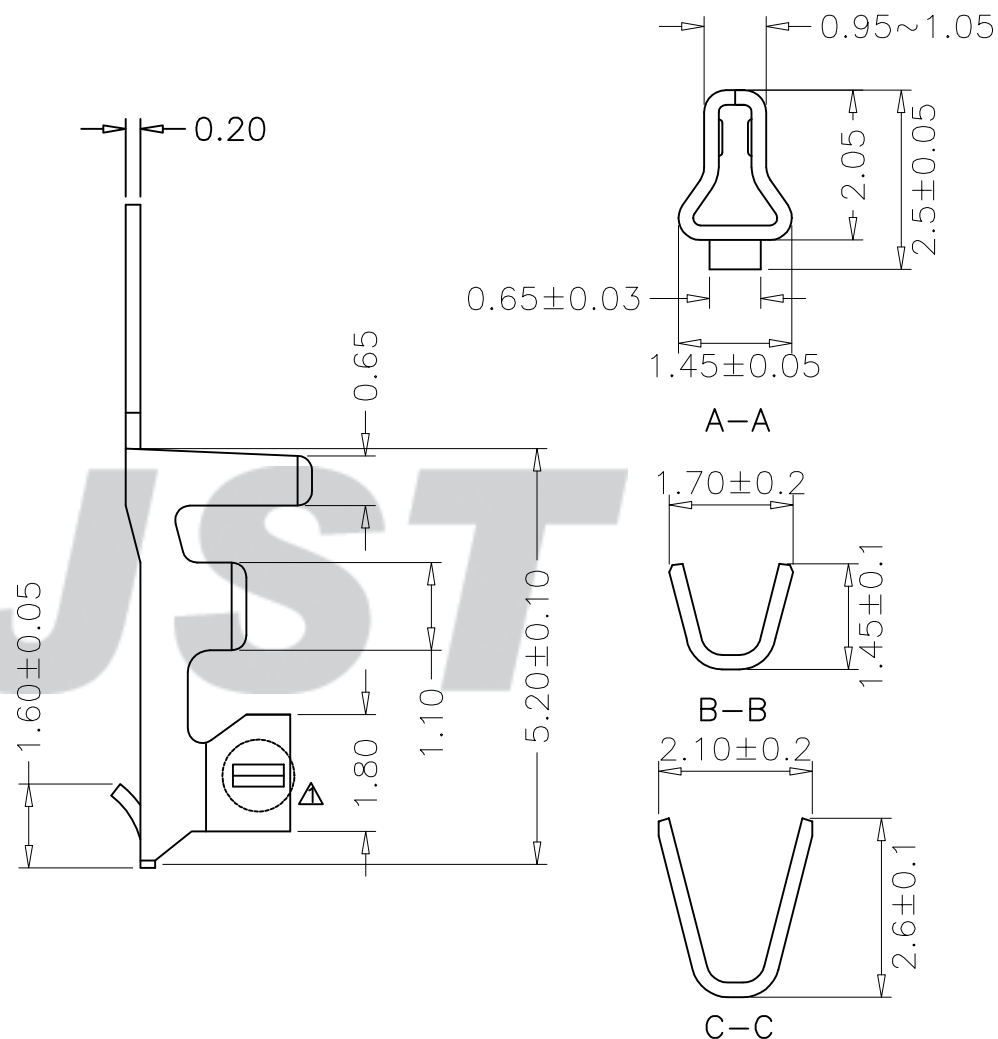

RoHS Compliant

端子图

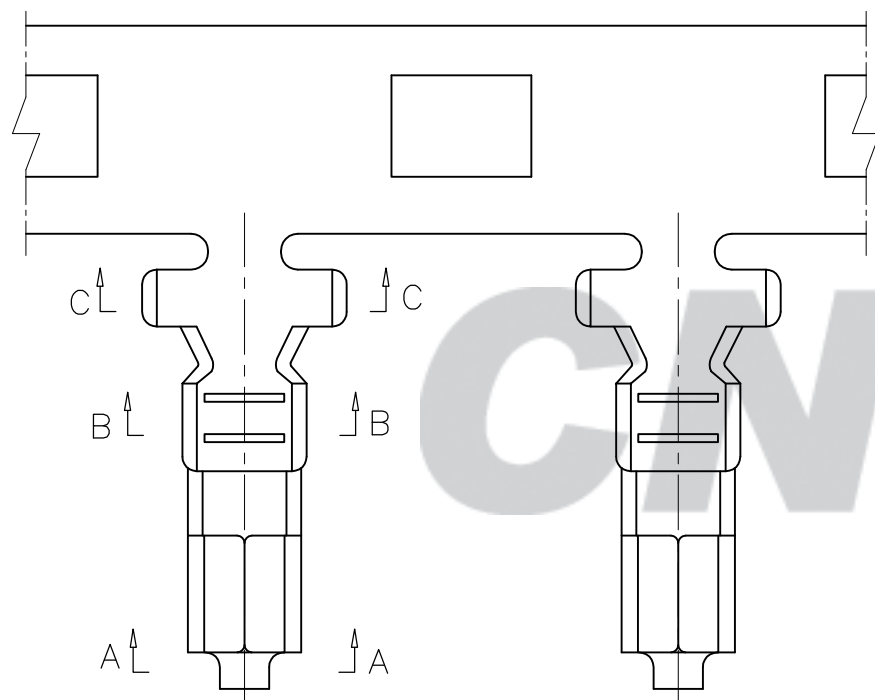

Tolerance X.X ±0.30 X.XX ±0.20 X.XXX ±0.10 Angle ±3.0°	Model Name: 2.00mm PITCH CRIMP TERMINAL		Drawn: 张育斌2016.06.13
	Model No: A2007T-PA-Z		
UNIT: mm		SCALE: FULL	REVISION: B/1
		CNJST 浙江捷仕泰电子有限公司 ZHEJIANG JIESHITAI ELECTRONIC CO., LTD	
		Checked: 林旭芝	
		Approved: 刘祚杰	
		DWG NO. CNJST/GCDZ-0037	

REV.	DATE	DESCRIPTION	APPD.	Wire Range	Insulation O.D.	QTY/Reel	Material	Plating
1	2013.01.01	NEW RELEASE		AWG #24~#28	1.50mm(max)	10,000Pcs	Phosphor Bronze	Tin-plated