

RoHS Compliant

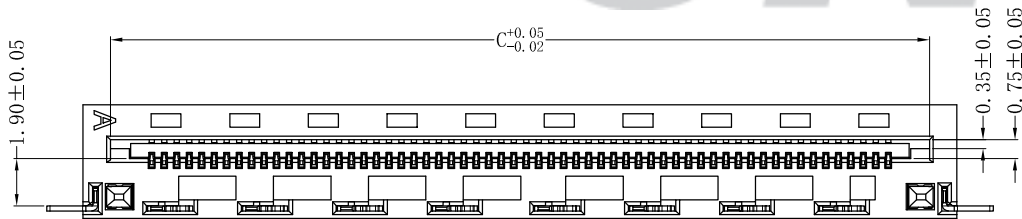

*注: 建议客户使用我司配套的线材, 配套线端使用镀金工艺。

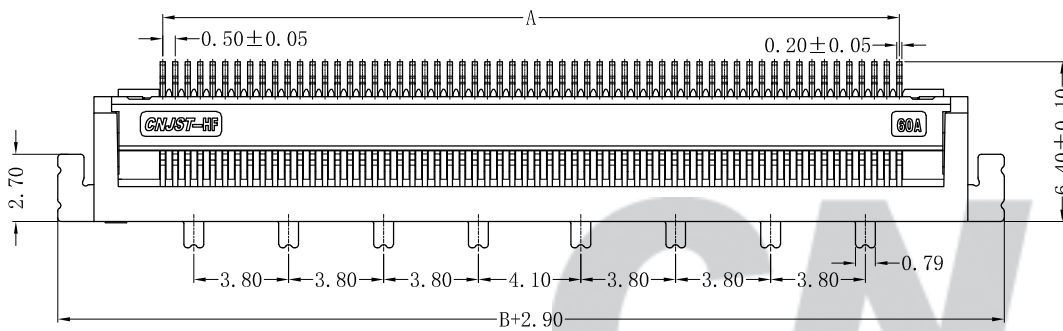
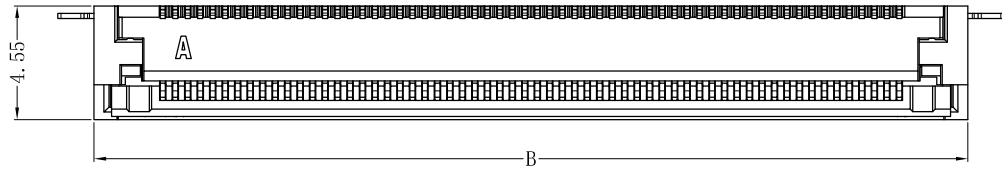
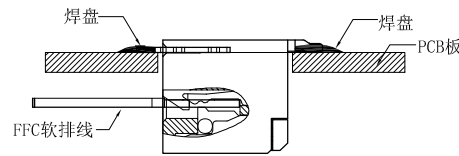
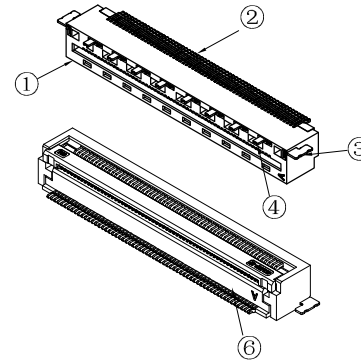

上板状态

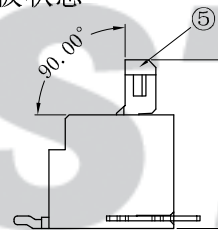

开合状态

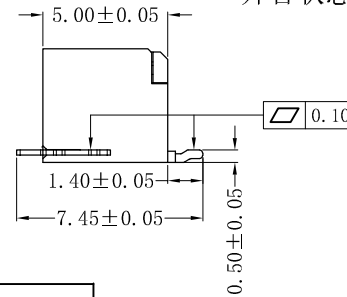

SPECIFICATION

- 1 Contact resistance: $\leq 30m\Omega$
- 2 Insulation resistance: $\geq 100M\Omega$
- 3 Rated voltage: 50 V AC DC
- 4 Rated current: 0.5 A AC DC
- 5 Withstand Voltage: 500V AC/minute
- 6 Temperature Range: $-25^{\circ}C \sim +85^{\circ}C$

ORDER INFORMATION:

| | | | |
|---------------------|--|---------------|--|
| FA0503AWR-**-F2MC-R | | | |
| PART No.: | | PACKAGING: | |
| No. OF CIRCUITS: | | R=Reel | |
| PLASTIC MATERIAL: | | PLATING: | |
| F2M=LCP (Nature) | | C=Gold-plated | |

| Circuits | Dimensions (mm) | | |
|----------|-----------------|-------|-------|
| | A | B | C |
| 51 | 25.00 | 30.50 | 28.30 |
| 60 | 29.50 | 35.00 | 32.80 |

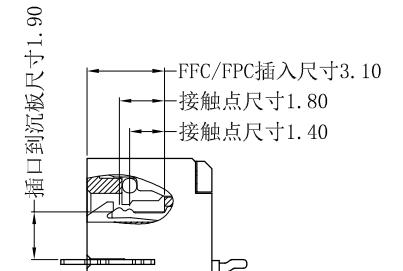

| | | | | |
|-----|-------------|-------|-----------------|---|
| ⑥ | Back cover | 1 | LCP (UL94V-0) | Nature |
| ⑤ | Locker | 1 | LCP (UL94V-0) | Black |
| ④ | Solder Tab | 7/8 | SUS301 | Matte Sn |
| ③ | Solder Tab | 2 | Brass | Matte Sn |
| ② | Contacts | 51/60 | Phosphor Bronze | Gold-plated(Contact point 1 μ m Min, Solder Area Gold Flash), over Ni: 0.75 μ m Min |
| ① | Insulator | 1 | LCP (UL94V-0) | Nature |
| NO. | DESCRIPTION | QTY | MATERIAL | PLATING/COLOR |

| |
|-------------------------|
| Tolerance |
| X.X ± 0.30 |
| X.XX ± 0.20 |
| X.XXX ± 0.10 |
| Angle $\pm 3.0^{\circ}$ |

UNIT: mm

CNJST 捷仕泰企业

Model No.: FA0503AWR-**-F2MC-R

Model Name: 0.50mm pitch 90° FFC/FPC TYPE

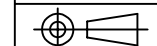

SCALE: FULL

REVISION: C/0

Drawn: 黄美程 2022.07.11

Checked: 吴丹平

Approved: 林旭芝

DWG NO. CNJST/GCCP-0808

专利产品

RoHS Compliant

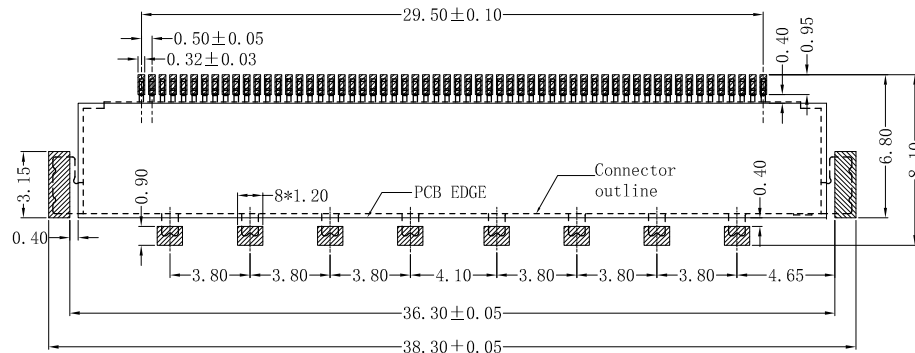

60P

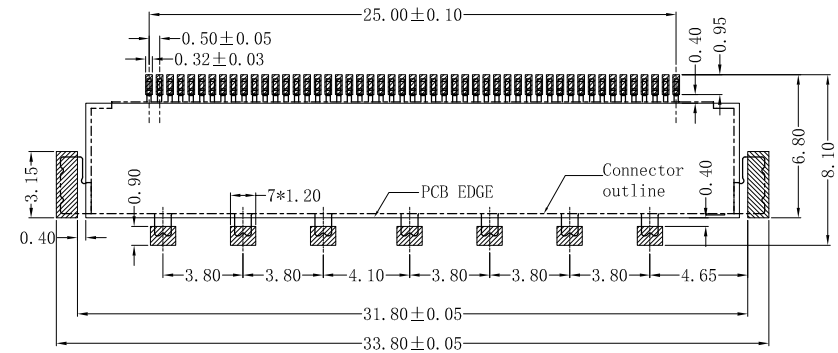

51P

SUGGESTED PCB LAYOUT
(COMPONENT SIDE)

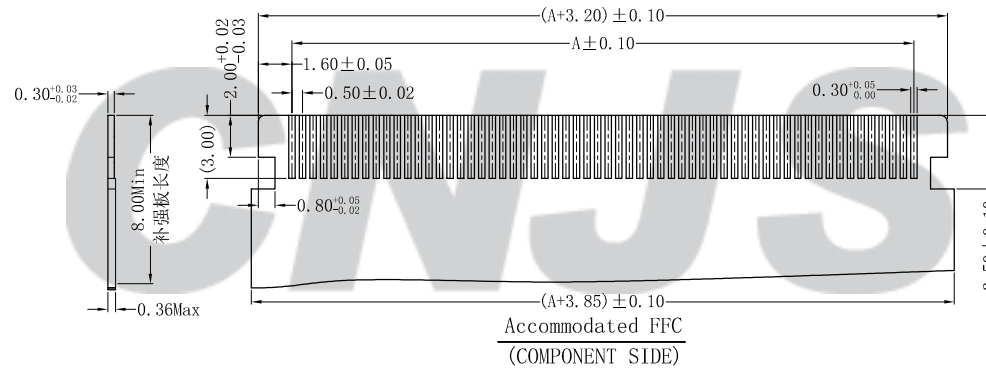

Accommodated FFC
(COMPONENT SIDE)

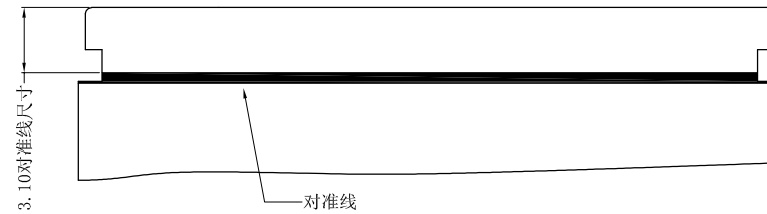

THE BACK VIEW

| Circuits | Dimensions (mm) |
|----------|-----------------|
| | A |
| 51 | 25.00 |
| 60 | 29.50 |

专利产品

| REV. | DATE | DESCRIPTION | APPD. |
|------|--------------|-------------|-------|
| C/0 | 2022. 07. 11 | 更新模板 | 黄羨程 |

| | | | |
|--|---|-------------|-------------------------|
| Tolerance X.X ±0.30 X.XX ±0.20 X.XXX ±0.10 Angle ±3.0° | CNJST 捷仕泰企业 | | Drawn: 黄羨程 2022. 07. 11 |
| | Model No.: FA0503AWR-**-F2MC-R | | Checked: 吴丹平 |
| UNIT: mm | Model Name: 0.50mm pitch 90° FFC/FPC TYPE | | Approved: 林旭芝 |
| | | SCALE: FULL | REVISION: C/0 |
| | | | DWG NO. CNJST/GCCP-0808 |