

RoHS Compliant

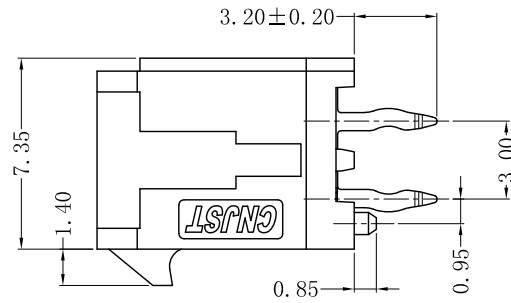
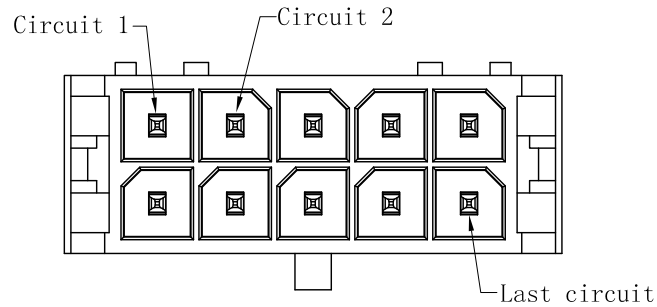

SPECIFICATION

- 1 Contact resistance: $\leq 10m\Omega$
- 2 Insulation resistance: $\geq 1000M\Omega$
- 3 Rated voltage: 250 V AC DC
- 4 Rated current: 5.0 A AC DC
- 5 Withstand Voltage: 1000V AC/minute
- 6 Temperature Range: $-40^{\circ}C \sim +125^{\circ}C$

ORDER INFORMATION:

QA3001AB-*-F2KB-G**

PART No.:			
No. OF CIRCUITS:	2X2~2X12	PACKAGING:	G=TUBE
PLASTIC MATERIAL:	F2K=LCP (Black)	PLATING:	B=Mattn Sn

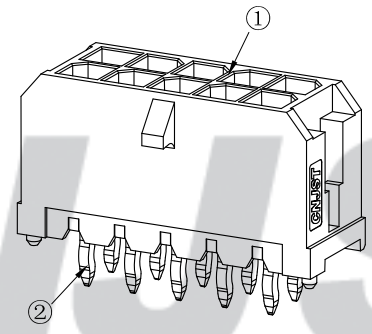
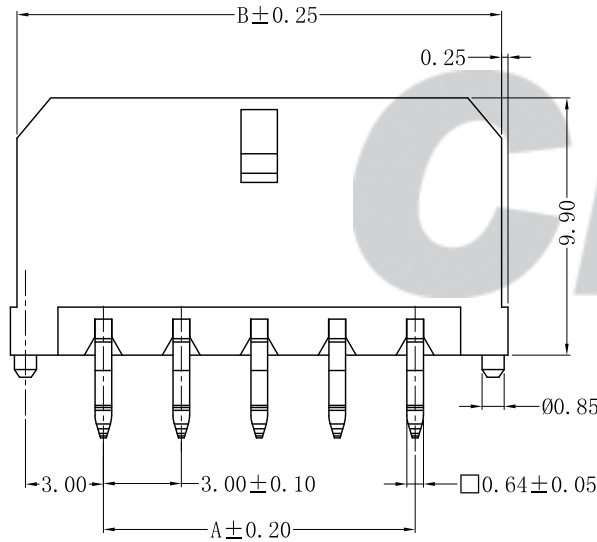

Circuits	Dimensions (mm)	
	A	B
202 (2X2)	3.00	9.65
203 (2X3)	6.00	12.65
204 (2X4)	9.00	15.65
205 (2X5)	12.00	18.65
206 (2X6)	15.00	21.65
207 (2X7)	18.00	24.65
208 (2X8)	21.00	27.65
209 (2X9)	24.00	30.65
210 (2X10)	27.00	33.65
211 (2X11)	30.00	36.65
212 (2X12)	33.00	39.65

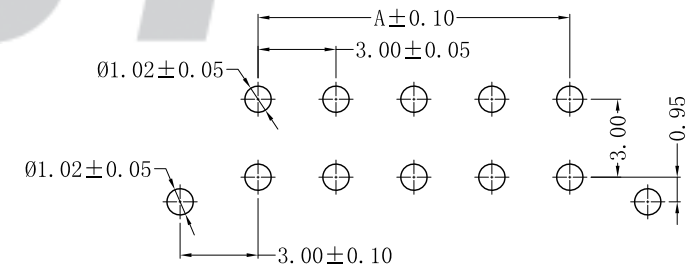

SUGGESTED PCB LAYOUT
(COMPONENT SIDE)

注：建议客户优先选择我司公母端产品配套使用，若在没有使用我司公母端配套产品情况下，出现因产品不匹配的质量问题，我司将不承担任何风险及责任。

专利产品

REV.	DATE	DESCRIPTION	APPD.	NO.	DESCRIPTION	QTY	MATERIAL	PLATING/COLOR
C/1	2023.06.12	详见ECR JST2023004	王丽君	②	Contacts	4~24	Brass	Matte Sn
C/0	2022.12.14	详见ECR JST2022020	王丽君	①	Insulator	1	LCP(UL94V-0)	Black

Tolerance	X.X ±0.30
	X.XX ±0.20
	X.XXX ±0.10
Angle	±3.0°

CNJST捷仕泰企业	
Model No.: QA3001AB-***-F2KB-G	
Model Name: 3.00mm PITCH 180° WAFER	

Drawn: 王丽君 2023.06.12
Checked: 吴丹平
Approved: 林旭芝
DWG NO. CNJST/GCCP-0639

UNIT: mm

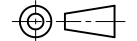

SCALE: FULL REVISION: C/1

RoHS Compliant

PIN位结构示意图:

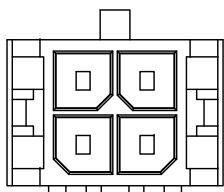

202

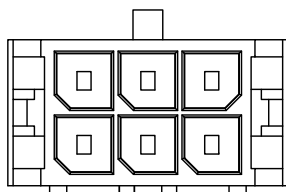

203

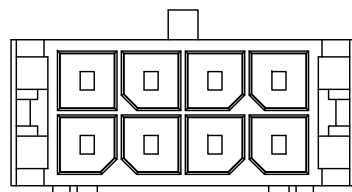

204

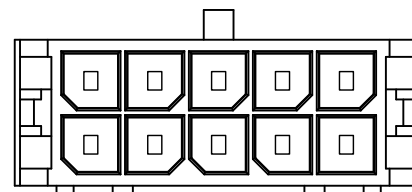

205

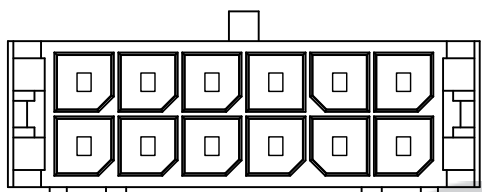

206

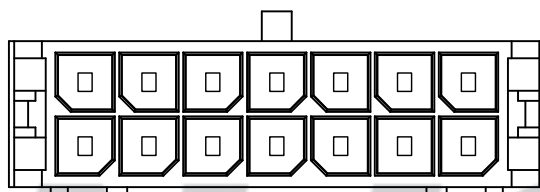

207

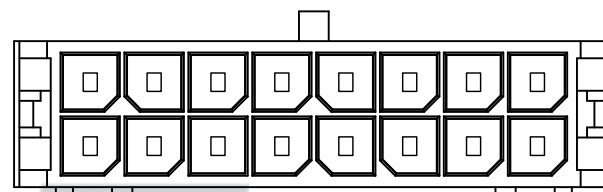

208

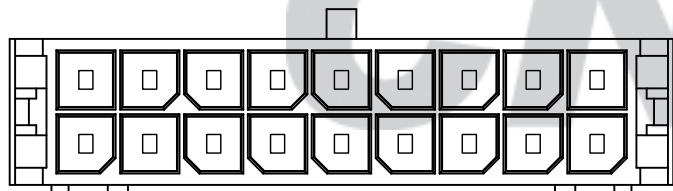

209

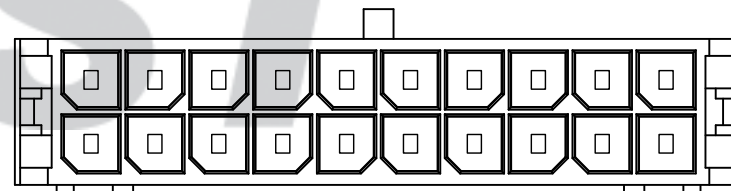

210

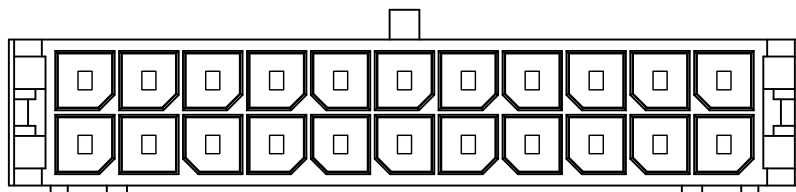

211

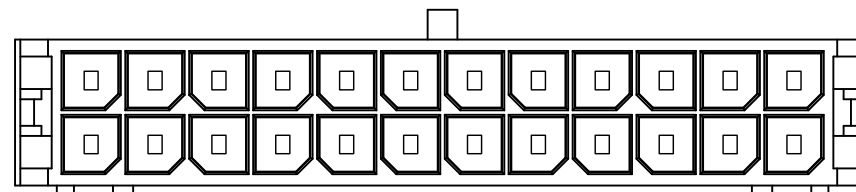

212

注: 建议客户优先选择我司公母端产品配套使用, 若在没有使用我司公母端配套产品情况下, 出现因产品不匹配的质量问题, 我司将不承担任何风险及责任。

专利产品

C/1	2023.06.12	详见ECR_JST2023004	王丽君
C/0	2022.12.14	详见ECR_JST2022020	王丽君
REV.	DATE	DESCRIPTION	APPD.

Tolerance X.X ±0.30 X.XX ±0.20 X.XXX ±0.10 Angle ±3.0°	CNJST捷仕泰企业		Drawn: 王丽君 2023.06.12
	Model No.: QA3001AB-***-F2KB-G		Checked: 吴丹平
UNIT: mm	Model Name: 3.00mm PITCH 180° WAFER		Approved: 林旭芝
		SCALE: FULL	REVISION: C/1
			DWG NO. CNJST/GCCP-0639