

RoHS Compliant

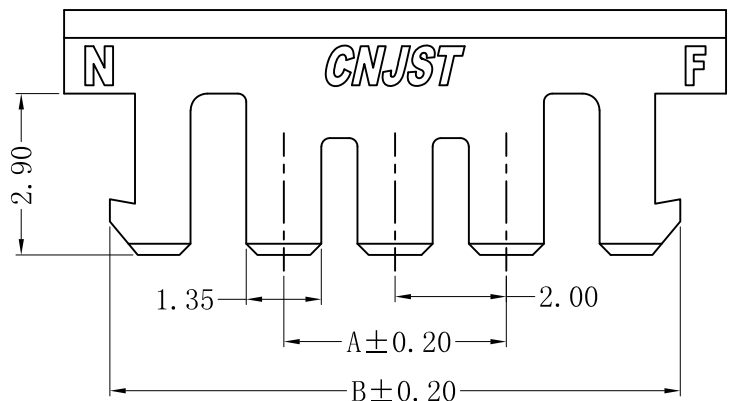

5P及以上

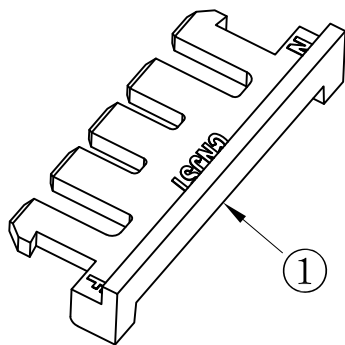

SPECIFICATION

1 Temperature Range: -40°C ~ +125°C

ORDER INFORMATION:

QA2004S--A6R-P**

PART No. No. OF CIRCUITS: 02-16 PACKAGING: P=PE PLASTIC MATERIAL: A6R=PA66 (Red)

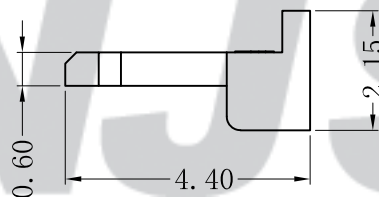
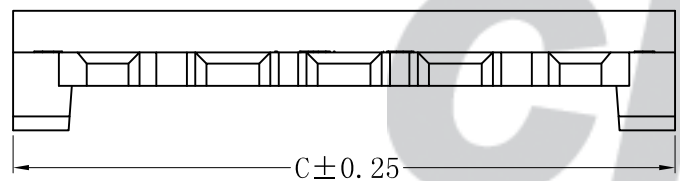

Circuits	Dimensions (mm)		
	A	B	C
02		4.25	5.90
03		6.25	7.90
04	2.00	8.25	9.90
05	4.00	10.25	11.90
06	6.00	12.25	13.90
07	8.00	14.25	15.90
08	10.00	16.25	17.90
09	12.00	18.25	19.90
10	14.00	20.25	21.90
11	16.00	22.25	23.90
12	18.00	24.25	25.90
13	20.00	26.25	27.90
14	22.00	28.25	29.90
15	24.00	30.25	31.90
16	26.00	32.25	33.90

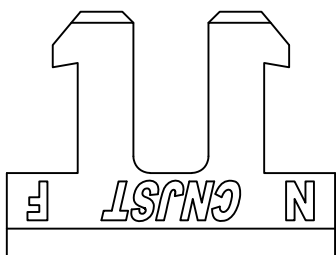

2P

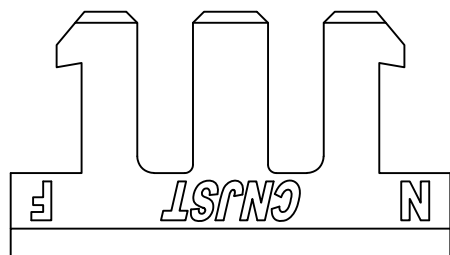

3P

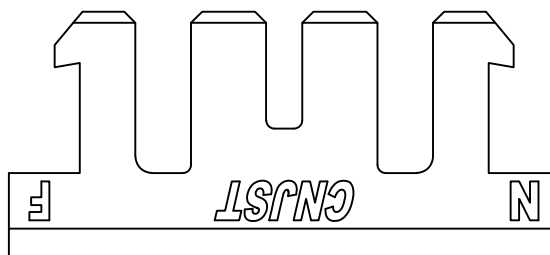

4P

专利产品

注：建议客户优先选择我司公母端产品配套使用，若在没有使用我司公母端配套产品情况下，出现因产品不匹配的质量问题，我司将不承担任何风险及责任。

Tolerance X.X ±0.30 X.XX ±0.20 X.XXX ±0.10 Angle ±3.0°	CNJST 捷仕泰企业		Drawn: 李浩然 2022.12.09
	Model No.: QA2004S-**-A6R-P		Checked: 吴丹平
	Model Name: 2.00mm PITCH HOUSING-Lock		Approved: 林旭芝
	UNIT: mm	SCALE: FULL	REVISION: C/0
		DWG NO.: CNJST/GCCP-0635	

REV.	DATE	DESCRIPTION	APPD.	NO.	DESCRIPTION	QTY	MATERIAL	PLATING/COLOR
C/0	2022.12.09	更新模板	李浩然	①	Insulator	1	PA66 (UL94V-0)	Red
B/0	2020.01.04	NEW RELEASE						