

RoHS Compliant

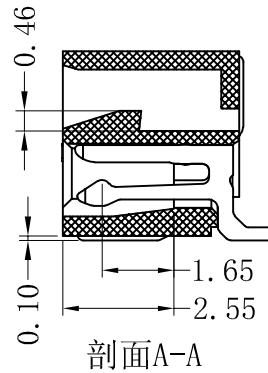
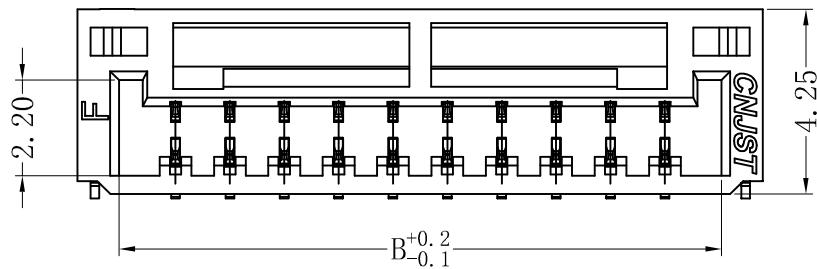

SPECIFICATION

- 1 Contact resistance: $\leq 30m\Omega$
- 2 Insulation resistance: $\geq 100M\Omega$
- 3 Rated voltage: 150 V AC DC
- 4 Rated current: 1.0 A AC DC
- 5 Withstand Voltage: 500V AC/minute
- 6 Temperature Range: $-25^{\circ}C \sim +85^{\circ}C$

ORDER INFORMATION:

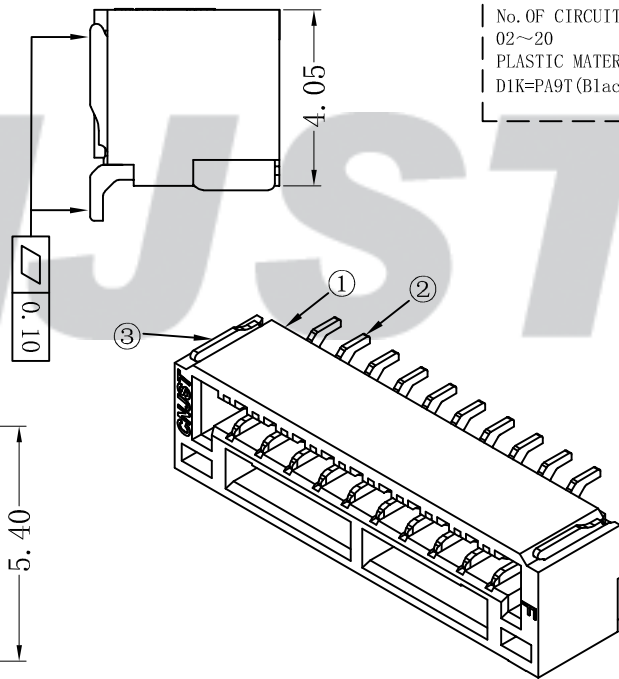
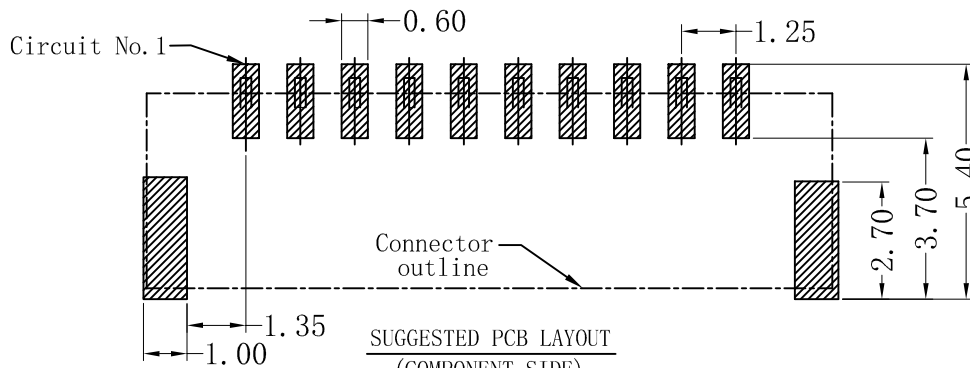
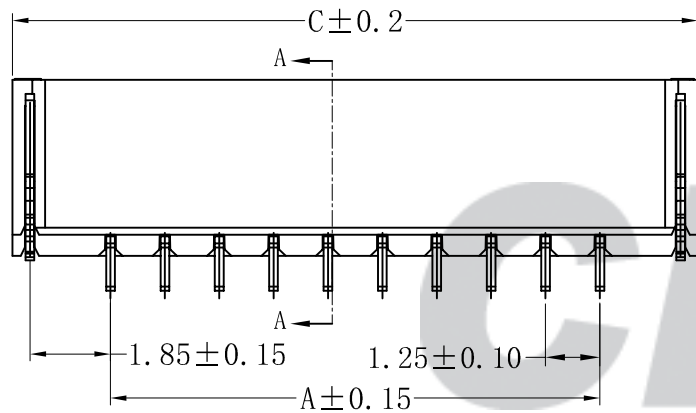
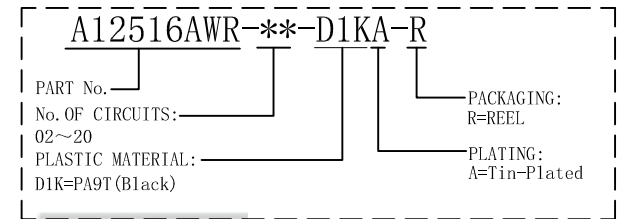

Circuit No.	Dimensions		
	A	B	C
02	1.25	3.85	5.75
03	2.50	5.10	7.00
04	3.75	6.35	8.25
05	5.00	7.60	9.50
06	6.25	8.85	10.75
07	7.50	10.10	12.00
08	8.75	11.35	13.25
09	10.00	12.60	14.50
10	11.25	13.85	15.75
11	12.50	15.10	17.00
12	13.75	16.35	18.25
13	15.00	17.60	19.50
14	16.25	18.85	20.75
15	17.50	20.10	22.00
16	18.75	21.35	23.25
18	21.25	23.85	25.75
20	23.75	26.35	28.25

Tolerance X.X ±0.30 X.XX ±0.20 X.XXX ±0.10 Angle ±3.0° UNIT: mm	CNJST 捷仕泰企业		Drawn: 黄美程 2022.12.07
	Model No.: A12516AWR-**-D1KA-R		Checked: 吴丹平
	Model Name: 1.25mm pitch 90° WAFER-SMT TYPE		Approved: 林旭芝
	SCALE: FULL REVISION: C/0		DWG NO.: CNJST/GCCP-0616

REV.	DATE	DESCRIPTION	APPD.	NO.	DESCRIPTION	QTY	MATERIAL	PLATING/COLOR
C/0	2022.12.07	统一标准 更新模版	黄美程	③	Solder Tab	2	Phosphor Bronze	Tin-plated
B/0	2021.07.26	NEW RELEASE	王程伟	②	Material	2~20	Phosphor Bronze	Tin-plated
				①	Insulator	1	PA9T (UL94V-0)	Black

RoHS Compliant

PIN位结构示意图

2P

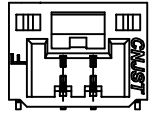

7P

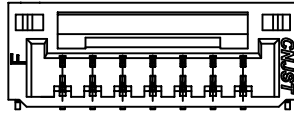

12P

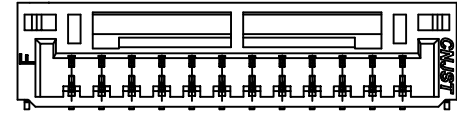

3P

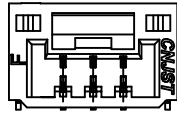

8P

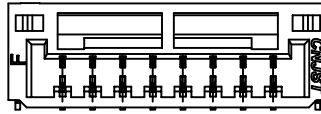

13P

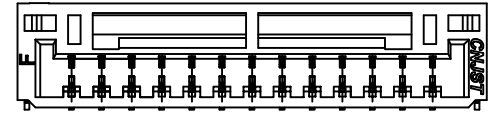

4P

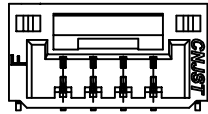

9P

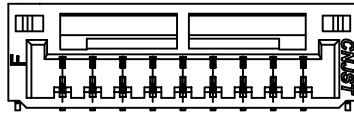

14P

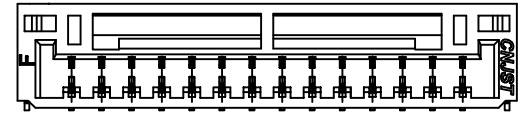

5P

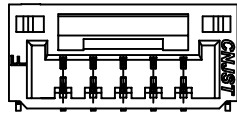

10P

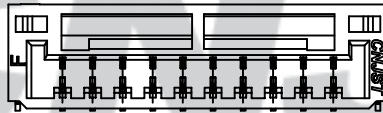

15P

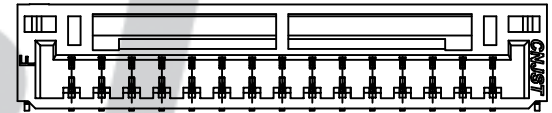

6P

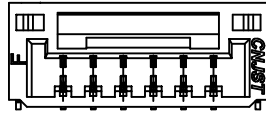

11P

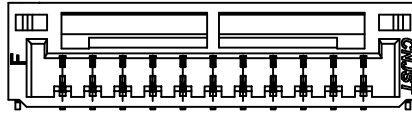

16P

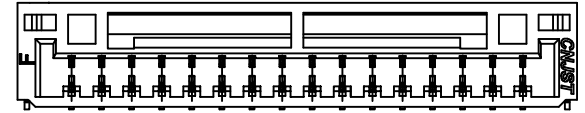

18P

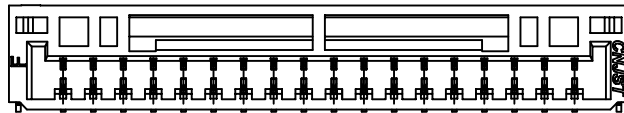

20P

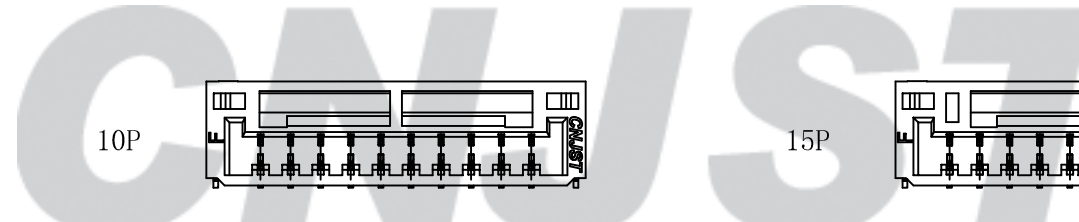
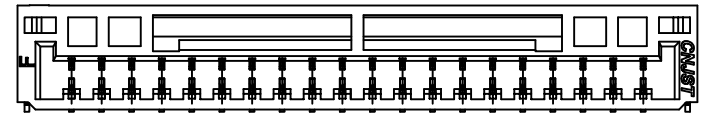

REV.	DATE	DESCRIPTION	APPD.	NO.	DESCRIPTION	QTY	MATERIAL	PLATING/COLOR
C/0	2022.12.07	统一标准 更新模版	黄羨程	③	Solder Tab	2	Phosphor Bronze	Tin-plated
B/0	2021.07.26	NEW RELEASE	王程伟	②	Material	2~20	Phosphor Bronze	Tin-plated
				①	Insulator	1	PA9T (UL94V-0)	Black

Tolerance	X.X ±0.30
	X.XX ±0.20
	X.XXX ±0.10
Angle	±3.0°
UNIT:	mm

CNJST 捷仕泰企业

Model No.: A12516AWR-**-D1KA-R

Model Name: 1.25mm pitch 90° WAFER-SMT TYPE

SCALE: FULL

REVISION: C/0

Drawn:	黄羨程 2022.12.07
Checked:	吴丹平
Approved:	林旭芝
DWG NO.:	CNJST/GCCP-0616