

RoHS Compliant

端子图

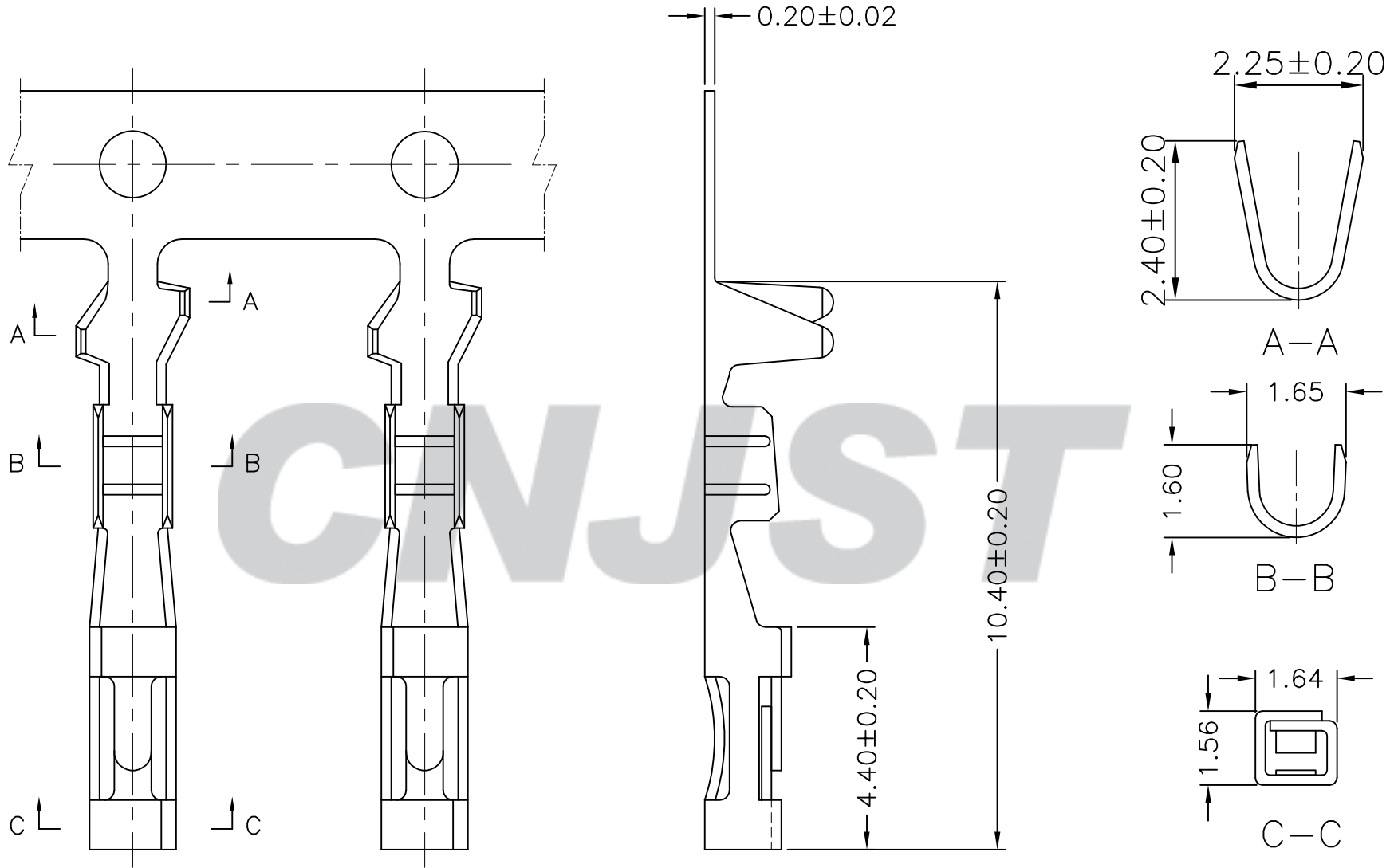
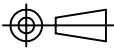

Tolerance X.X ±0.30 X.XX ±0.20 X.XXX ±0.10 Angle ±3.0°	Model Name: 2.54mm PITCH CRIMP TERMINAL		Drawn: 张育斌 2016.06.13
	Model No: A2541T-PA-Z		
UNIT: mm	 SCALE: FULL REVISION: B/1	Checked: 林旭芝	
		Approved: 刘祚杰	
<b>CNJST</b> 浙江捷仕泰电子有限公司 ZHEJIANG JIESHITAI ELECTRONIC CO., LTD		DWG NO. CNJST/GCDZ-0045	

REV.	DATE	DESCRIPTION	APPD.	Wire Range	Insulation O.D.	QTY/Reel	Material	Plating
1	2013.01.01	NEW RELEASE		AWG #26~#28	1.60mm(max)	10,000Pcs	Phosphor Bronze	Tin-plated